

SUBMITTAL: ACADEMY ALUMINUM FX FIRE-RATED EXTINGUISHER CABINETS

The Academy Series Features Aluminum Trim and Door, with 10 Door Styles & Optional Anodized Colors.

Door & Trim Construction: Clear anodized aluminum. Flush cabinet doors with a 5/8" door stop are attached by a continuous hinge and equipped with zinc-plated handle and roller catch. All models have 1-3/4" trim on face and door.

Trim Style & Depth: Recessed 3/8" flat trim, Semi Recessed - 1-1/4", 1-1/2" Square Edge or 2-1/2", 3", 4", 4-1/2" Rolled Edge (4" has recessed ADAC pull).

Tub: The double tub is constructed of cold rolled steel with white powder-coat finish standard. Tub forms a flange to cover cut edges of wallboard material. Fire-resistant material is sandwiched between the layers of steel.

Fire-Rating: The recessed and semi-recessed Fire-FX™ cabinets are fabricated in accordance with the Warnock Hersey label for one and two hour combustible and non-combustible wall system building codes. The fire testing has met the requirement of the UBC standard 43-6 and ASTM-E814-83 for membrane and penetration firestops. Installation instructions must be strictly adhered to in order to obtain the fire rating. The installation of any fire-rated cabinet which lacks a cabinet door or a condition in which the door is left ajar, will void the fire rating.

STEP 1: SELECT MODEL NUMBER AND QUANTITY ON CHART (refer to chart on pg 2)

A. Determine Trim Style according to wall depth. B. Determine Tub I.D. according to size most suited for extinguisher and wall opening.

STEP 2: SELECT DOOR STYLE WITH HANDLE

Check one box below Examples on Page 2

- | | |
|---|--|
| <input type="checkbox"/> F Full Glazing | <input type="checkbox"/> L22 Solid with SAF-T-LOK™ |
| <input type="checkbox"/> G Full Glazing with SAF-T-LOK™ | <input type="checkbox"/> L24 Sold with Cylinder Lock - No Handle |
| <input type="checkbox"/> D Horizontal Duo Panel | <input type="checkbox"/> V Vertical Duo |
| <input type="checkbox"/> E Horizontal Dual Panel with SAF-T-LOK™ | <input type="checkbox"/> W Vertical Duo with SAF-T-LOK™ |
| <input type="checkbox"/> S21 Solid Door | <input type="checkbox"/> B Solid with Small View Window & Safety Lock |

STEP 3: SELECT DOOR GLAZING



(Check one box below)

- | | | |
|---|---|---|
| <input type="checkbox"/> 10 Clear Acrylic | <input type="checkbox"/> 15 Bronze Acrylic | <input type="checkbox"/> 17 Clear Tempered Glass |
| <input type="checkbox"/> 13 Clear Wire Glass | <input type="checkbox"/> 16 Gray Acrylic | <input type="checkbox"/> 18 Laminated Safety Glass |

STEP 4: OPTIONAL FEATURES AT ADDED COST (SELECT ANY)

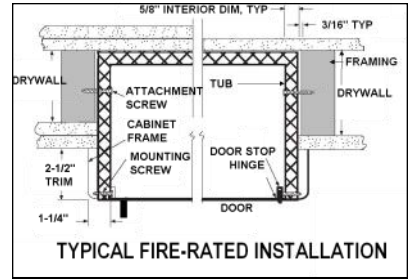
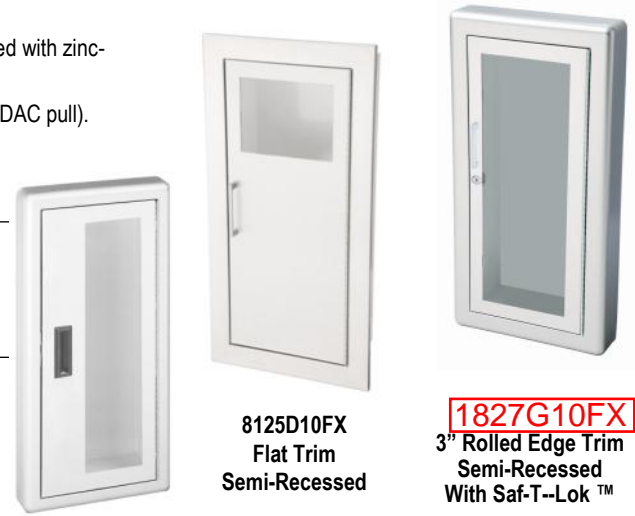
- | | | | |
|---|--|--|---|
| <input type="checkbox"/> Optional Tub Color: ___ Black ___ Red | <input type="checkbox"/> Black Vertical FE Letters LDCVBF | <input type="checkbox"/> Black Vertical Decal LDVBF | <input type="checkbox"/> (CA) Commander Alarm |
| <input type="checkbox"/> Futura "Fire" Pull ___ Mill Alum ___ Red ___ White | <input type="checkbox"/> Red Vertical FE Letters LDCVRF | <input type="checkbox"/> Red Vertical Decal LDVRF | <input type="checkbox"/> (BA) Brigadier Alarm |
| <input type="checkbox"/> ADAC Flush Pull Handle | <input type="checkbox"/> White Vertical FE Letters LDCVWF | <input type="checkbox"/> White Vertical Decal LDVWF | <input type="checkbox"/> Etched or Engraved Lettering in Glass or Metal |
| <input type="checkbox"/> Polished Chrome Lever Handle (P6) | <input type="checkbox"/> Black Horizontal FE Letters LDCHBF | <input type="checkbox"/> Black Horizontal Decal LDHBF | |
| <input type="checkbox"/> <u>Optional Anodized Color Finish:</u> ___ Lt Bronze | <input type="checkbox"/> Red Horizontal FE Letters LDCHRF | <input type="checkbox"/> Red Horizontal Decal LDHRF | |
| ___ Med. Bronze ___ Dark Bronze | <input type="checkbox"/> White Horizontal FE Letters LDCHWF | <input type="checkbox"/> White Horizontal Decal LDHWF | |



 JL INDUSTRIES	 www.activarcpg.com	Distributor:	Quantity:
		Contractor:	Approved By:
		Model #:	Architect:
		Project:	Date:
HEADQUARTERS & JL INDUSTRIES: 4450 WEST 78 TH ST CIRCLE, BLOOMINGTON, MN 55435-5416 PH: 800-554-6077 FAX: 952-835-2218 EMAIL: SALES@JLINDUSTRIES.COM WWW.ACTIVARCPG.COM ACPG SOUTHEAST (THOMAS ENTERPRISES): FT MYERS, FL ACPG WEST COAST (SAMSON): COMMERCE, CA WAREHOUSES: DALLAS TX, LANCASTER PA, ATLANTA GA, CHICAGO IL, SEATTLE WA 9-11-12			

SUBMITTAL: ACADEMY FX FIRE-RATED FIRE EXTINGUISHER CABINETS

TRIM & DOOR SERIES #			Tub I.D.			Frame O.D.		Fx Wall Opening			Extinguisher
QTY	Model	Trim Style	A	B	C	E	F	W	H	D	
	8125	Flat trim	9	18	5 1/2	12 3/8	21 3/8	11	20 1/8	6 3/8	Cosmic & Galaxy 2 1/2-6, Mercury 2 1/2- 5
	8126	1 1/2 Square	9	18	5 1/2	12 3/8	21 3/8	11	20 1/8	4 7/8	
	8127	2 1/2 Rolled	9	18	5 1/2	12 3/8	21 3/8	11	20 1/8	4 5/8	
	1720	2-1/4 Square	10 1/2	24	5	13 7/8	27 3/8	12 1/2	26 1/8	3 5/8	Cosmic & Galaxy 2 1/2-10. (10 lb must be mounted on back of tub) Mercury 2 1/2-5
	1825	Flat trim	10 1/2	24	5 1/2	13 7/8	27 3/8	12 1/2	26 1/8	6 3/8	
	1826	1 1/2 Square	10 1/2	24	5 1/2	13 7/8	27 3/8	12 1/2	26 1/8	4 7/8	
	1827	3 Rolled	10 1/2	24	5 1/2	13 7/8	27 3/8	12 1/2	26 1/8	3 1/2	
	1822	4 Rolled/ADA Pull	10 1/2	24	5 1/2	13 7/8	27 3/8	12 1/2	26 1/8	3 3/8	
	1828	4 1/2 Rolled	10 1/2	24	5 1/2	13 7/8	27 3/8	12 1/2	26 1/8	2 5/8	
	1025	Flat trim	10 1/2	24	6	13 7/8	27 3/8	12 1/2	26 1/8	6 7/8	Any Cosmic. Galaxy, Mercury, Saturn or Grenadier P (20 lb must be mounted on back of tub), Sentinel 5 & 10
	1026	1 1/2 Square	10 1/2	24	6	13 7/8	27 3/8	12 1/2	26 1/8	5 3/8	
	1027	3 Rolled	10 1/2	24	6	13 7/8	27 3/8	12 1/2	26 1/8	4	
	1022	4 Rolled/ADA Pull	10 1/2	24	6	13 7/8	27 3/8	12 1/2	26 1/8	3 5/8	
	1028	4 1/2 Rolled	10 1/2	24	6	13 7/8	27 3/8	12 1/2	26 1/8	3 3/8	
	2025	Flat trim	12	27	7 3/4	15 3/8	30 3/8	14	29 1/8	8 1/2	Any Cosmic. Galaxy, Mercury, Saturn or Grenadier P (20 lb must be mounted on back of tub), Sentinel 5 & 10
	2026	1 1/4 Square	12	27	7 3/4	15 3/8	30 3/8	14	29 1/8	7 3/8	
	2027	2 1/2 Rolled	12	27	7 3/4	15 3/8	30 3/8	14	29 1/8	7	
	2022	4 Rolled/ADA Pull	12	27	7 3/4	15 3/8	30 3/8	14	29 1/8	5 1/4	
	2028	4 1/2 Rolled	12	27	7 3/4	15 3/8	30 3/8	14	29 1/8	4 3/4	
	3025	Flat trim	16	32	7 3/4	19 3/8	35 3/8	18	34 1/8	8 1/2	Any Cosmic. Galaxy, Mercury, Saturn or Grenadier P (20 lb must be mounted on back of tub), Sentinel 5-15, 272
	3026	1 1/4 Square	16	32	7 3/4	19 3/8	35 3/8	18	34 1/8	7 3/8	
	3027	2 1/2 Rolled	17	34	9	20 3/8	38 3/8	18	34 1/8	7	
	3022	4 Rolled/ADA Pull	16	32	7 3/4	19 3/8	35 3/8	18	34 1/8	5-1/4	
	3028	4 1/2 Rolled	16	32	7 3/4	19 3/8	35 3/8	18	34 1/8	4 3/4	
	4025	Flat trim	20	27	7 3/4	23 3/8	30 3/8	22	29 1/8	8 1/2	Two each of: any Cosmic, Galaxy, Mercury, Saturn or Grenadier P (20 lb must be mounted on back of tub), Sentinel 5
	4026	1 1/4 Square	20	27	7 3/4	23 3/8	30 3/8	22	29 1/8	7 3/8	
	4027	2 1/2 Rolled	20	27	7 3/4	23 3/8	30 3/8	22	29 1/8	7	
	4022	4 Rolled/ADA Pull	20	27	7 3/4	23 3/8	30 3/8	22	29 1/8	5 1/4	
	4028	4 1/2 Rolled	20	27	7 3/4	23 3/8	30 3/8	22	29 1/8	4 3/4	

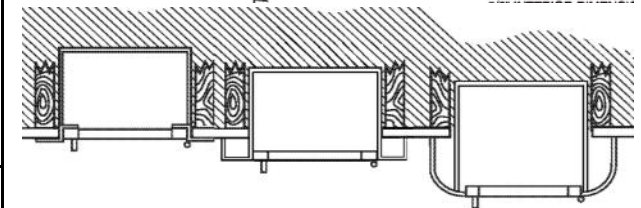
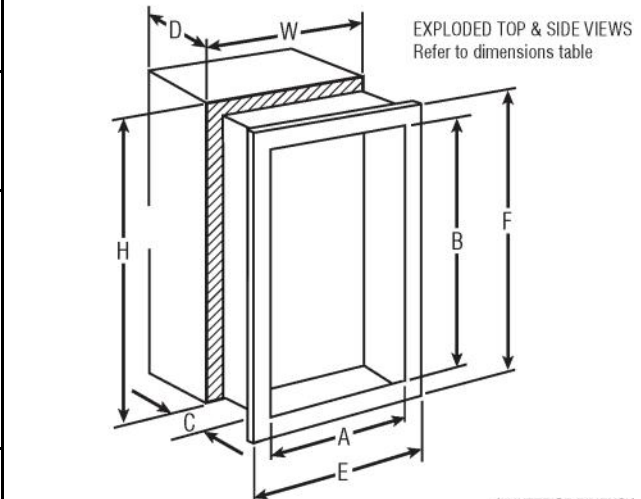

3/8" (.9cm) FLAT TRIM **1-1/2" (3.8cm) SQUARE TRIM** **2-1/2, 3, 4" ROLLED EDGE**

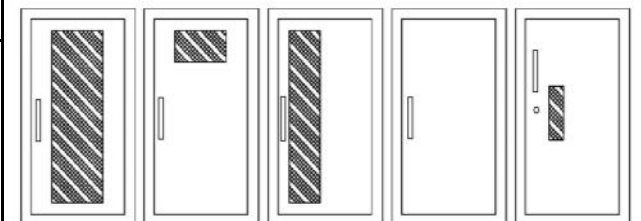

- F - Full glass with pull handle
- G - Full glass with pull handle and Saf-T-Lok
- D - Horizontal duo panel with pull handle
- E - Horizontal duo panel with pull handle and Saf-T-Lok
- V - Vertical duo panel with pull handle
- W - Vertical duo panel with pull handle and Saf-T-Lok
- S21 - Solid with pull handle
- L22 - Solid with pull handle and Saf-T-Lok
- L24 - Solid with cylinder key lock and no handle
- B - Solid with pull handle, view window and Saf-T-Lok

Models shown in **Large Bold** above are available in several door styles for Quick Shipment. [See current Stock](#)

[VIEW ABOVE DOORS ONLINE](#)